

Date: 040613 Sign. LJE

Stenhøj A/S
 E-mail: info@stenhoj.dk
 FAX: +45 76 82 13 31

1:50 0 ½ 1m

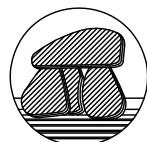

STENHØJ

Nr. T11561

Dimension sketch
 MS45WL-52

Rev. date: 220813

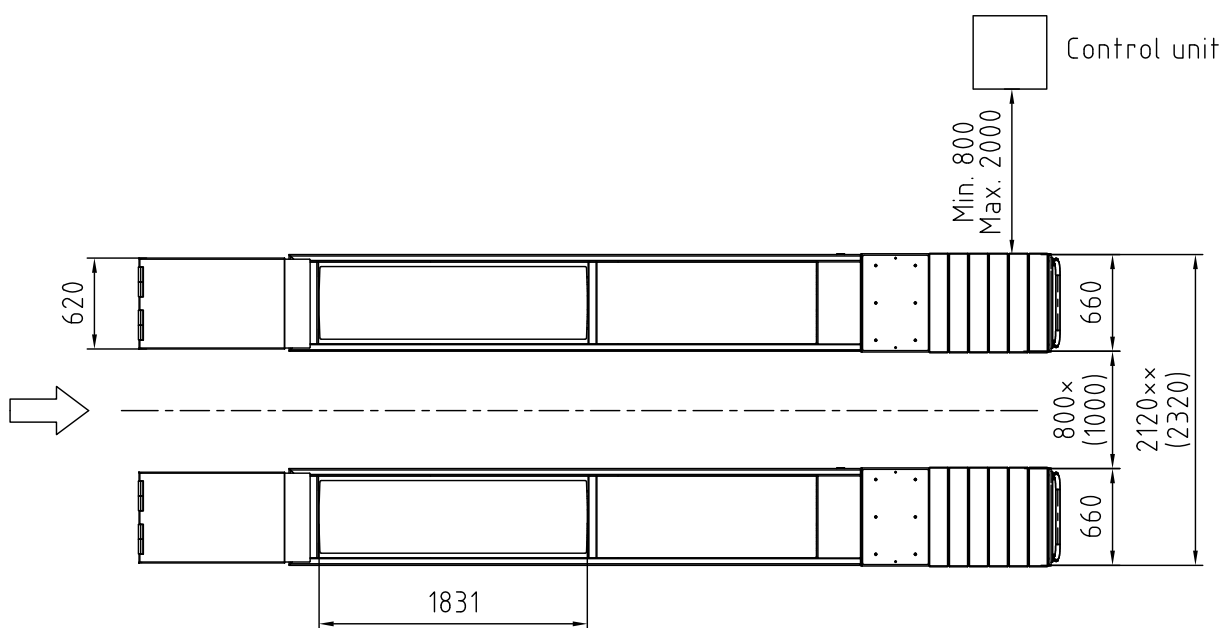
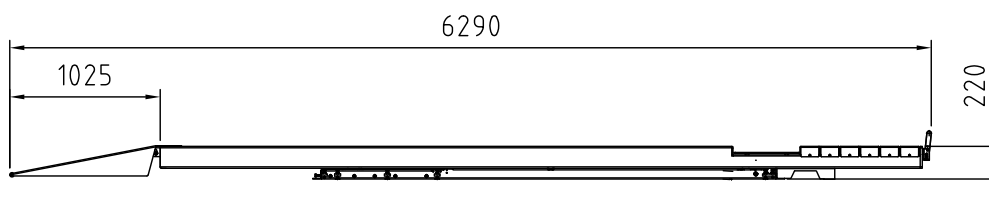
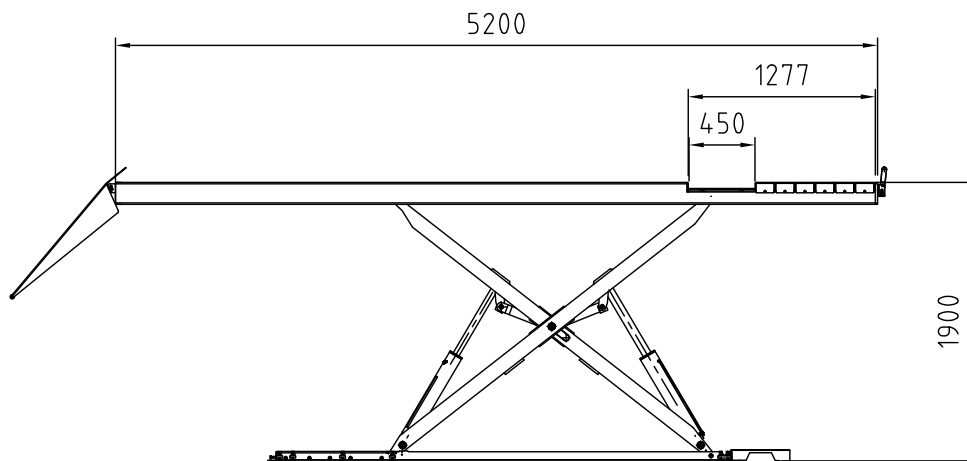

x) Recommended distance (with scissor jack = 875mm)
 xx) Recommended distance (with scissor jack = 2195mm)